

Data Sheet



Article number: 339707320000

Description: Multibeam 6 Coupling 707.32.0000
Aluminium relieved & clamp hubs

Measures

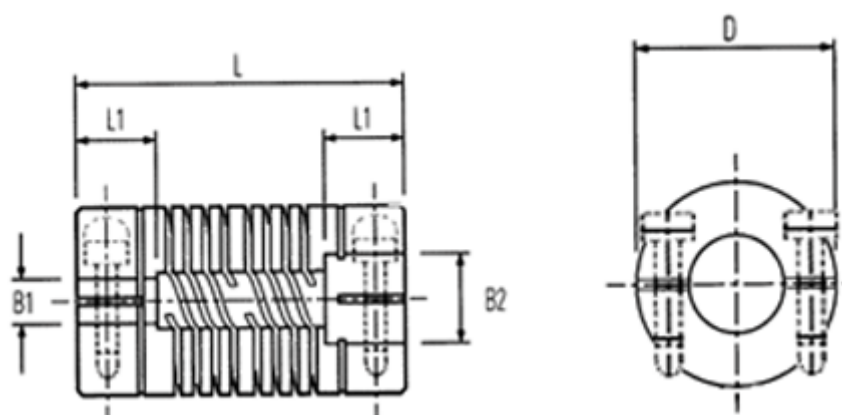

B2: Pre-drilled	= 8.0
B2: Pre-drilled	= 10.00
Cap screw	= M4
D	= 31.8
L	= 57.2
L1	= 16.0
Max angular displacement	= 0.50
Max B1 & B2	= 16.00

Max parallel displacement	= 7
Peak Torque NM	= 15.00